

Flared Copper Couplings

Flare Copper to Flare Copper

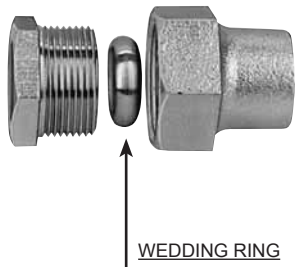

For Flare Copper to Flare Copper (2 part) coupling (supplied with wedding ring)

CATALOG NUMBER	DESCRIPTION		APPROX. WT. LBS.	STD. PKG. QTY.
	FLARE COPPER	FLARE COPPER		
STRAIGHT COUPLINGS				
CS22-33	3/4"	3/4"	.6	25
CS22-44	1"	1"	1.0	15
CS22-55	1-1/4"	1-1/4"	1.5	10
CS22-66	1-1/2"	1-1/2"	2.5	6
CS22-77	2"	2"	5.0	3



Wedding Ring Only for (2 part) coupling

CATALOG NUMBER	SIZE AND COUPLING APPLICATIONS	APPROX. WT. LBS.	STD. PKG. QTY.
WR-3	3/4" for CS22-33	.1	-
WR-4	1" for CS22-44	.1	-
WR-5	1-1/4" for CS22-55	.1	-
WR-6	1-1/2" for CS22-66	.2	-
WR-7	2" for CS22-77	.3	-

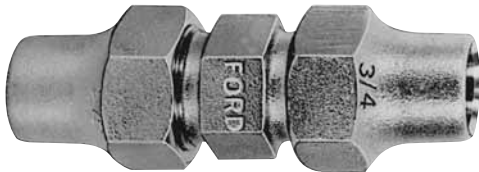

For Flare Copper to Flare Copper (3 part) coupling

CATALOG NUMBER	DESCRIPTION		APPROX. WT. LBS.	STD. PKG. QTY.
	FLARE COPPER	FLARE COPPER		
STRAIGHT COUPLINGS				
C22-11	1/2"	1/2"	.6	30
C22-12	1/2"	5/8"	.8	-
C22-13	1/2"	3/4"	.8	20
C22-22	5/8"	5/8"	.8	20
C22-23	5/8"	3/4"	1.0	15
C22-33	3/4"	3/4"	1.1	14
C22-34	3/4"	1"	1.4	12
C22-44	1"	1"	2.0	6
C22-55	1-1/4"	1-1/4"	2.9	4
C22-66	1-1/2"	1-1/2"	4.4	7
C22-77	2"	2"	8.5	1
ELL COUPLINGS				
L22-33	3/4"	3/4"	1.2	14
L22-34	3/4"	1"	1.5	-
L22-44	1"	1"	1.8	8
L22-66	1-1/2"	1-1/2"	4.7	2
L22-77	2"	2"	9.0	2

Flared Copper Couplings

Branch Connections and Service Tees

ANSI/NSF Standard 61
see page J-2

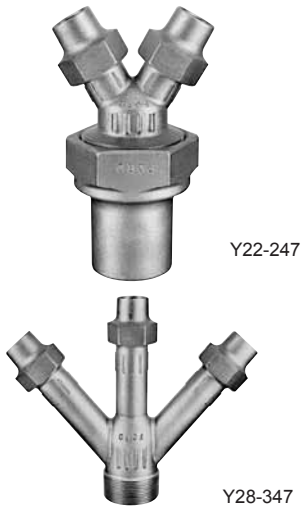

"Y" Branch Connections

CATALOG NUMBER	DESCRIPTION		APPROX. WT. LBS.	STD. PKG. QTY.
	MULTI-BRANCH END	SINGLE BRANCH END		
TWO BRANCH CONNECTIONS				
Y21-246	Two 1" flare cop. conns.	x 1-1/2" female iron pipe	3.3	2
Y21-247	Two 1" flare cop. conns.	x 2" female iron pipe	4.1	2
Y22-243	Two 3/4" flare cop. conns.	x 1" flare copper	2.0	5
Y22-246	Two 1" flare cop. conns.	x 1-1/2" flare copper	4.3	2
Y22-247	Two 1" flare cop. conns.	x 2" flare copper	6.0	4
Y28-234	Two 3/4" flare cop. conns.	x 1" male iron pipe	1.4	8
Y28-246	Two 1" flare cop. conns.	x 1-1/2" male iron pipe	2.9	4
Y28-247	Two 1" flare cop. conns.	x 2" male iron pipe	2.9	2
Y88-247	Two 1" male iron pipe conns.	x 2" male iron pipe	1.6	-
THREE BRANCH CONNECTIONS				
Y21-347	Three 1" flare cop. conns.	x 2" female iron pipe	5.6	1
Y22-346	Three 1" flare cop. conns.	x 1-1/2" flare copper	6.6	-
Y22-347	Three 1" flare cop. conns.	x 2" flare copper	8.6	5
Y28-346	Three 1" flare cop. conns.	x 1-1/2" male iron pipe	5.3	4
Y28-347	Three 1" flare cop. conns.	x 2" male iron pipe	5.3	5



Multi-Service "Y"

CATALOG NUMBER	DESCRIPTION		APPROX. WT. LBS.	STD. PKG. QTY.
	SINGLE INLET	MULTI-OUTLET		
Y11-474	2" female iron pipe	x Four 1" female iron pipe	3.3	3

Service Tees

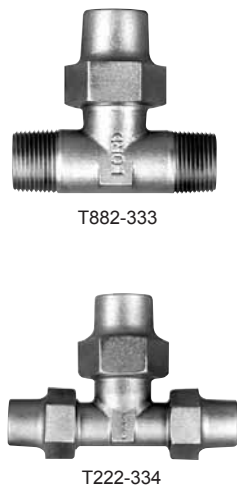

CATALOG NUMBER	DESCRIPTION		APPROX. WT. LBS.	STD. PKG. QTY.
	BOTH ENDS (RUN)	OUTLET SIDE		
T111-333	3/4" female iron pipe	x 3/4" female iron pipe	-	-
T111-444	1" female iron pipe	x 1" female iron pipe	-	-
T181-333	3/4" FIP to 3/4" MIP	x 3/4" female iron pipe	0.7	-
T181-664	1-1/2" FIP to 1-1/2" MIP	x 1" female iron pipe	2.2	1
T181-774	2" FIP to 2" MIP	x 1" female iron pipe	2.4	1
T222-113	1/2" flare copper	x 3/4" flare copper	1.1	10
T222-333	3/4" flare copper	x 3/4" flare copper	1.6	8
T222-334	3/4" flare copper	x 1" flare copper	2.1	5
T222-443	1" flare copper	x 3/4" flare copper	2.4	6
T222-444	1" flare copper	x 1" flare copper	2.9	4
T222-445	1" flare copper	x 1-1/4" flare copper	3.6	-
T222-664	1-1/2" flare copper	x 1" flare copper	5.3	5
T222-666	1-1/2" flare copper	x 1-1/2" flare copper	6.8	4
*T222-774-AWT	2" flare copper	x 1" flare copper	14.1	2
T222-777	2" flare copper	x 2" flare copper	12.5	3
T228-333	3/4" flare copper	x 3/4" male iron pipe	1.3	8
T228-334	3/4" flare copper	x 1" male iron pipe	1.4	-
T228-444	1" flare copper	x 1" male iron pipe	2.2	5
T282-333	3/4" fl. cop. to 3/4" MIP	x 3/4" flare copper	1.3	-
T282-334	3/4" fl. cop. to 3/4" MIP	x 1" flare copper	1.8	-
T282-444	1" fl. cop. to 1" MIP	x 1" flare copper	2.4	-
T882-333	3/4" male iron pipe	x 3/4" flare copper	1.0	-
T882-334	3/4" male iron pipe	x 1" flare copper	1.3	10
T882-444	1" male iron pipe	x 1" flare copper	1.7	-
T888-333	3/4" male iron pipe	x 3/4" male iron pipe	0.6	20
T888-334	3/4" male iron pipe	x 1" male iron pipe	0.7	10
T888-444	1" male iron pipe	x 1" male iron pipe	0.9	10
T888-445	1" male iron pipe	x 1-1/4" male iron pipe	1.0	-
T888-777	2" male iron pipe	x 2" male iron pipe	3.9	-

* Note: This item is manufactured from two castings assembled watertight.



Multi-Service Tee

CATALOG NUMBER	DESCRIPTION		APPROX. WT. LBS.	STD. PKG. QTY.
	SINGLE INLET	MULTI-OUTLET		
T11-663	1-1/2" female iron pipe	x Six 3/4" female iron pipe	1.8	5
T11-674	2" female iron pipe	x Six 1" female iron pipe	3.0	4

Flared Copper Couplings

Service Tees and Adapters

Adapters for Flare Copper Connections (Replaces Flare Nut)

CATALOG NUMBER	DESCRIPTION		APPROX. WT. LBS.	STD. PKG. QTY.
COPPER TUBE NUTS WITH MALE IRON PIPE THREADS ON SMALL END				
C08-33	3/4" female copper thread	x 3/4" male iron pipe	.4	40
C08-43	1" female copper thread	x 3/4" male iron pipe	.6	20
C08-44	1" female copper thread	x 1" male iron pipe	.7	20
C08-45	1" female copper thread	x 1-1/4" male iron pipe	.8	-
C08-66	1-1/2" female copper thread	x 1-1/2" male iron pipe	1.5	6
C08-77	2" female copper thread	x 2" male iron pipe	2.5	3
COPPER TUBE NUTS WITH FEMALE IRON PIPE THREAD CONNECTIONS				
C01-11	1/2" female copper thread	x 1/2" female iron pipe	.4	42
C01-13	1/2" female copper thread	x 3/4" female iron pipe	.4	-
C01-33	3/4" female copper thread	x 3/4" female iron pipe	.4	40
C01-34	3/4" female copper thread	x 1" female iron pipe	.7	25
C01-43	1" female copper thread	x 3/4" female iron pipe	.8	-
C01-44	1" female copper thread	x 1" female iron pipe	.8	15
C01-55	1-1/4" female copper thread	x 1-1/4" female iron pipe	1.0	10
C01-65	1-1/2" female copper thread	x 1-1/4" female iron pipe	1.7	-
C01-66	1-1/2" female copper thread	x 1-1/2" female iron pipe	1.4	8
C01-67	1-1/2" female copper thread	x 2" female iron pipe	1.7	-
C01-75	2" female copper thread	x 1-1/4" female iron pipe	3.1	-
C01-77	2" female copper thread	x 2" female iron pipe	2.4	3
PIGGY BACK NUTS AND INCREASERS				
C02-23	5/8" female copper thread	x 3/4" flare copper	.7	25
C02-31	3/4" female copper thread	x 1/2" flare copper	.5	30
C02-32	3/4" female copper thread	x 5/8" flare copper	.6	25
C02-33	3/4" female copper thread	x 3/4" flare copper	.7	-
C02-34	3/4" female copper thread	x 1" flare copper	1.0	15
C02-43	1" female copper thread	x 3/4" flare copper	1.0	15
C02-44	1" female copper thread	x 1" flare copper	1.3	-
C02-45	1" female copper thread	x 1-1/4" flare copper	1.7	-
C02-54	1-1/4" female copper thread	x 1" flare copper	1.4	10
C02-64	1-1/2" female copper thread	x 1" flare copper	2.2	5
C02-65	1-1/2" female copper thread	x 1-1/4" flare copper	2.5	8
C02-74	2" female copper thread	x 1" flare copper	3.5	3
C02-75	2" female copper thread	x 1-1/4" flare copper	4.0	-
C02-76	2" female copper thread	x 1-1/2" flare copper	4.4	2
QUARTER BEND COUPLINGS				
L02-33	3/4" female copper thread	x 3/4" flare copper	1.0	15
L02-44	1" female copper thread	x 1" flare copper	1.6	8
L02-66	1-1/2" female copper thread	x 1-1/2" flare copper	3.3	2
L02-77	2" female copper thread	x 2" flare copper	7.0	1
SWIVEL QUARTER BENDS				
L02-33S	3/4" fem. cop. thrd. swivel nut	x 3/4" flare copper	1.2	14
L02-44S	1" fem. cop. thrd. swivel nut	x 1" flare copper	1.8	8
L02-66S	1-1/2" fem. cop. thrd. swivel nut	x 1-1/2" flare copper	4.7	2
L02-77S	2" fem. cop. thrd. swivel nut	x 2" flare copper	8.0	1
EIGHTH BEND COUPLINGS				
LA02-33	3/4" female copper thread	x 3/4" flare copper	.8	18
LA02-44	1" female copper thread	x 1" flare copper	1.4	10
LA02-66	1-1/2" female copper thread	x 1-1/2" flare copper	3.3	2
LA02-77	2" female copper thread	x 2" flare copper	6.4	3
SWIVEL EIGHTH BENDS				
LA02-33S	3/4" fem. cop. thrd. swivel nut	x 3/4" flare copper	1.0	18
LA02-44S	1" fem. cop. thrd. swivel nut	x 1" flare copper	1.5	10
LA02-66S	1-1/2" fem. cop. thrd. swivel nut	x 1-1/2" flare copper	4.3	2
LA02-77S	2" fem. cop. thrd. swivel nut	x 2" flare copper	7.7	-

To order C02, L02 and LA02 adapters less the copper tube nut, add "-LN" to the end of the catalog number.

Copper washers included on sizes 3/4" and above.



Copper Tube Nuts, Discs and Copper Gaskets



Copper Tube Nuts

CATALOG NUMBER	DESCRIPTION CONNECTION SIZE	APPROX. WT. LBS.	STD. PKG. QTY.
CTN-1	1/2"	.2	-
CTN-2	5/8"	.2	-
CTN-3	3/4"	.3	-
CTN-4	1"	.5	-
CTN-5	1-1/4"	.8	-
CTN-6	1-1/2"	1.1	-
CTN-7	2"	2.3	-

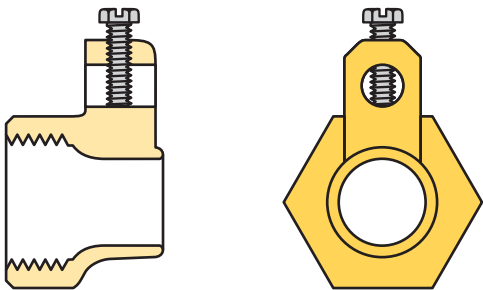

Thaw Wire Copper Tube Nuts

CATALOG NUMBER	DESCRIPTION CONNECTION SIZE	APPROX. WT. LBS.	STD. PKG. QTY.
CTN-3-TW	3/4"	.4	35
CTN-4-TW	1"	.7	15

These Copper Tube Nuts have a lug attachment for connecting an electric thawing wire.

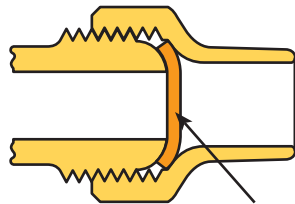

Copper Disc

Copper Discs - To Plug Service At Flare Copper Connections

CATALOG NUMBER	DESCRIPTION CONNECTION SIZE	APPROX. WT. LBS.	STD. PKG. QTY.
Disc-3	3/4"	.04	-
Disc-4	1"	.06	-
Disc-5	1-1/4"	.07	-
Disc-6	1-1/2"	.09	-
Disc-7	2"	.18	-

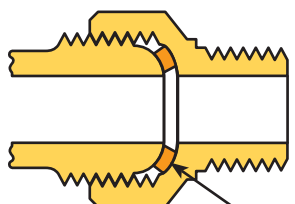

Copper Gasket

Copper Gaskets - To Use With Adapters Replacing Flare Nuts

CATALOG NUMBER	DESCRIPTION CONNECTION SIZE	APPROX. WT. LBS.	STD. PKG. QTY.
SLC-3	3/4"	.01	-
SLC-4	1"	.02	-
SLC-5	1-1/4"	.03	-
SLC-6	1-1/2"	.04	-
SLC-7	2"	.08	-