

# Tomorrow's Drainage System Today

 **Nyroplast** Storm Drainage Structures

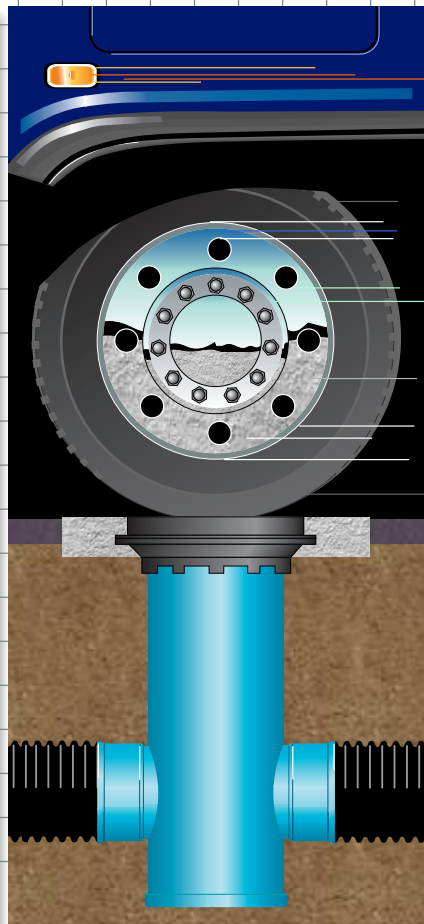

  
**Nyroplast**<sup>®</sup> Tomorrow's  
Storm Drainage  
Structures Today.

  
ADVANCED DRAINAGE SYSTEMS, INC.

The Preferred Solution for Storm Drainage Applications.



# About Nyloplast

**Nyloplast** specializes in the development, manufacture and sale of PVC plastic structures for underground piping systems based on our own unique production technologies. We serve the commercial, industrial, landscaping, government, general sport/recreation, golf course and other markets with a full line of custom fabricated heavy-duty road & highway structures, curb inlet structures, drain basins, inline drains, and drop-in grates.

**At Nyloplast**, we have seen the enormous cost of rebuilding yesterday's infrastructure, as metals and concrete complete their often limited service life. Today, the *engineered plastic system* is a reality, providing better hydraulic performance, extended service life, and cost efficiencies in installation and maintenance costs. Tomorrow, you will continue to see new products and applications from Nyloplast, the leader in drainage systems.

### Storm Water Treatment Products

We also have a full line of inserts and inlet protection devices designed to improve water quality as part of the National Pollution Discharge Elimination System (NPDES) and EPA phase II standards.

We invite your call to help solve problems or answer questions.

## ADS<sup>®</sup> Sales & Service Locations

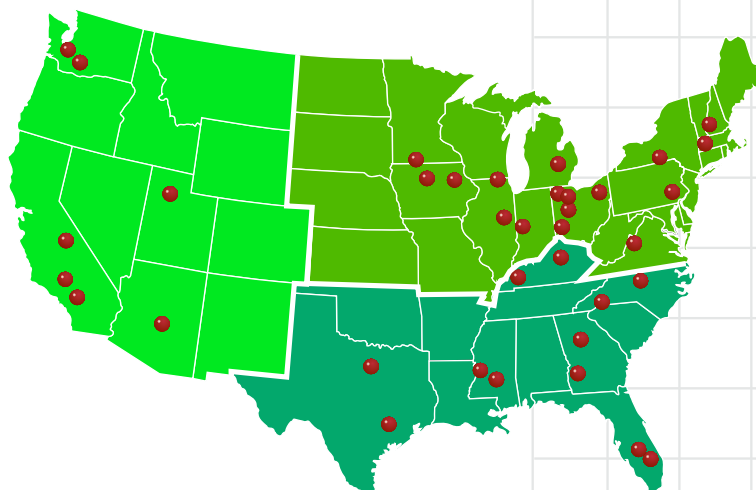

-  **Manufacturing Facility Locations**
-  **Midwest/Northeast Zone Office** London, OH • 1-800-733-9554
-  **Southern Zone Office** Franklin, TN • 1-800-733-9987
-  **Western Zone Office** Vancouver, WA • 1-800-733-8523



# Benefits

## Heavy Duty Construction

- Ductile Iron Grates
- PVC Bodies
- H-20 Rating
- No Corrosion or Degradation

## Easy, Economical Installation

- No Field Fabrication
- Easy Handling
- Rightsizing the Structure
- Offset Structure Design
- Easy Field Adjustment Using ADD-a-BRANCH™

## Watertight System

- Gasketed Push-On Joints
- Ductile Iron Grates



Easy Handling



Ductile Iron Grates



Offset Structure Design



No Field Fabrication



ADD-a-BRANCH™



Field Adjustments



Hinged Grates



Riser Joint Section



- Locking Grates
- Hinged Grates
- Outlets Fit Most of the Underground Plastic Piping Systems Available
- Ductile Iron Grates for Every Traffic Situation, Weight Load and Site Requirement
- Locking Flange Design
- NPDES Related Products
- Watertight Joint



NPDES Related Products





# Applications

- Residential
- Parks & Recreational
- Golf Courses
- Schools
- Commercial
- Government
- Road & Highway



*Residential*



*Parks & Recreational*



*Golf Courses*



*Schools*



*Commercial & Government*

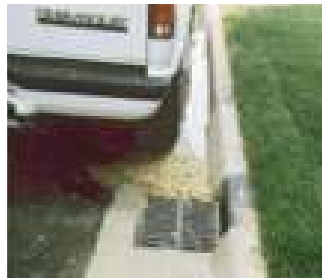

*Road & Highway*



## When are Drain Basins Used?

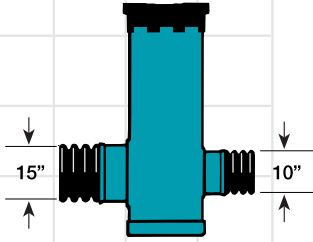

Change Diameter

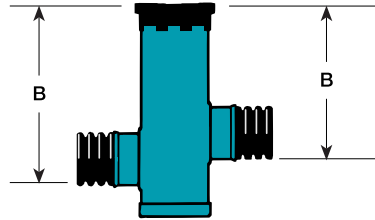

Change Elevation

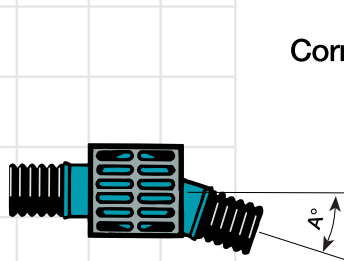

Change Direction

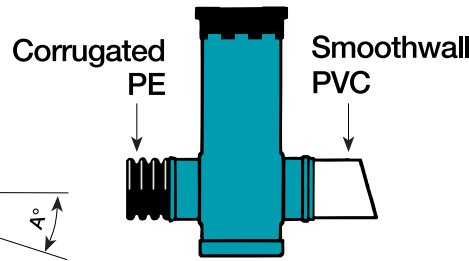

Change Pipe



## When are Inline Drains Used?

Inline Drains allow you to match inlet capacity to pipe capacity, reducing cost of riser pipe.

To enter an existing line by means of a riser and a tee.

At the beginning of a drain line.

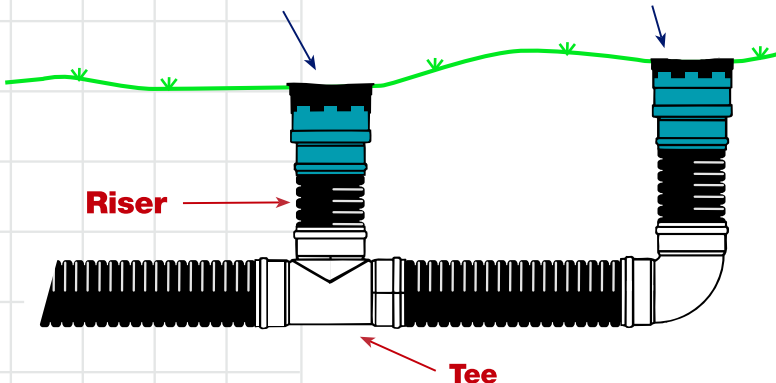

## Inline Drains



Nyloplast Inline Drains are designed to enter an existing line with a riser and tee, or for use at the beginning of a drain line. Nyloplast Structures represent the latest in storm water piping technology. Their innovative combination of performance proven ductile iron grates with a rugged, heavy-duty PVC structure makes them unique in the surface drainage field.



# Grate Options



## Ductile Iron Grates for Every Traffic Situation, Weight Load and Site Requirement

- H-20 Traffic Rated Grates
- H-10 Medium-Duty Grates
- Solid Covers H-20 Rated
- Bronze Grates
- Domed Grates
- Drop-in Grates
- ADA Compliant Grates
- Road & Highway Castings
- Curb Inlets



### Locking option is available for most grates.

All grate options are available for drain basins and inline drains.

### Grate Marker

Public education and outreach is part of the NPDES requirement. Storm drain marking is an established method of involving the public and increasing community awareness about nonpoint source pollution.

Many Nyloplast castings come with a recessed area on the grate designed to accommodate these grate markers.



Nyloplast keeps inventory of only the featured marker shown at left, however, other markers may be purchased in 100 piece lots as custom orders. Call for details.

### Ductile Iron Grates Conform to the following ASTM standard.

ASTM A536 grade 70-50-05 for ductile iron.



8", 10",  
Dome  
Light-Duty



18", 24" & 30"  
Dome  
Light-Duty



8" & 10"  
Standard  
Light-Duty  
*(also available  
in bronze)*



18"  
Standard  
H-20

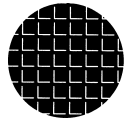

8" & 10"  
Solid  
Light-Duty

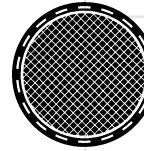

18" & 24"  
Solid  
H-20



12" & 15"  
Dome  
Light-Duty



18"  
Pedestrian  
H-10

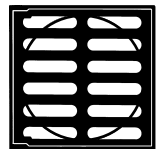

12" & 15"  
Standard  
H-20  
*Hinged  
Design*



24"  
Standard  
H-20

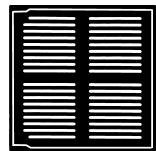

12" & 15"  
Pedestrian  
H-10  
*Hinged  
Design*



24"  
Pedestrian  
H-10



12" & 15"  
Pedestrian  
Light-Duty  
Bronze

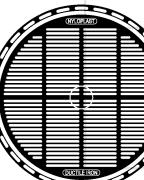

30"  
Pedestrian  
H-10

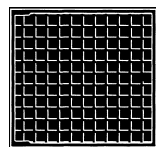

12" & 15"  
Solid  
H-20  
*Hinged  
Design*

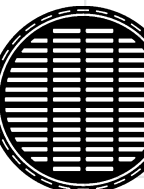

30"  
Standard  
H-20

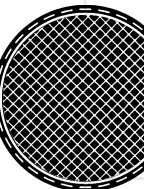

30"  
Solid  
H-20



### Drop-In Grates

Our light-duty Drop-In Grates, available in sizes 8" through 24", provide easy installation by eliminating the need for a frame. They also adapt to a variety of commonly used pipes.





# Grate Options

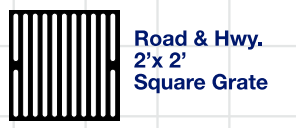

Road & Hwy.  
2'x 2'  
Square Grate

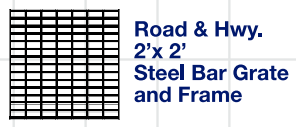

Road & Hwy.  
2'x 2'  
Steel Bar Grate  
and Frame

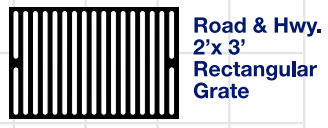

Road & Hwy.  
2'x 3'  
Rectangular  
Grate

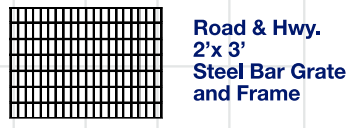

Road & Hwy.  
2'x 3'  
Steel Bar Grate  
and Frame

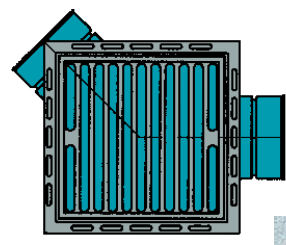

TOP VIEW

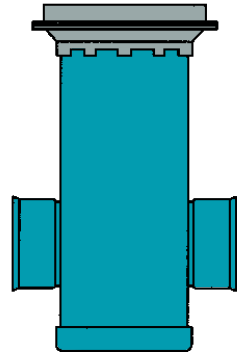

SIDE VIEW

# Road & Highway Structures

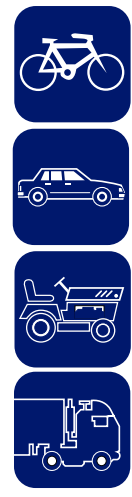
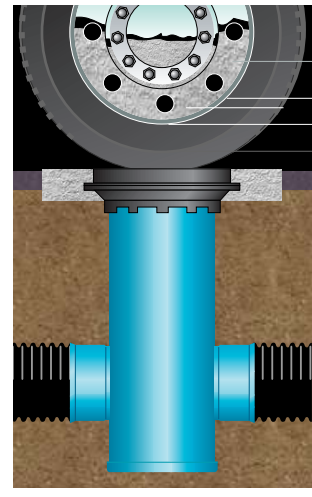

Nyloplast Road & Highway Structures offer all of the Nyloplast product benefits such as heavy-duty construction, easy, economical installation and a watertight system. Plus, our H-20 rated ductile iron grates provide maximum strength for traffic applications.

# Grate Options



Curb Inlet  
2'x 2'  
Standard  
Grate



Curb Inlet  
2'x 2'  
Diagonal Flow  
Grate



Curb Inlet  
2'x 3'  
Diagonal Flow  
Grate



Curb Inlet  
2'x 3'  
High Flow  
Vane Grate

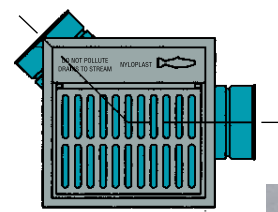

TOP VIEW

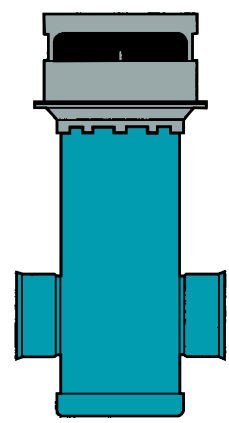

SIDE VIEW

# Curb Inlet Structures

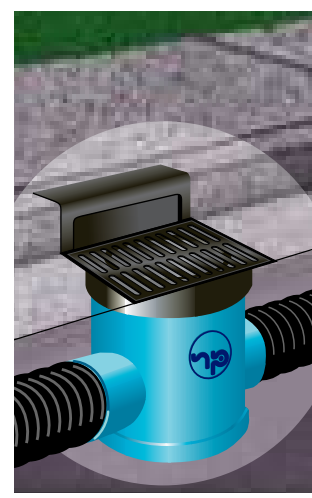

Nyloplast Curb Inlet Structures include all the advantages of our drain basins and fit drainage pipe up to 30".

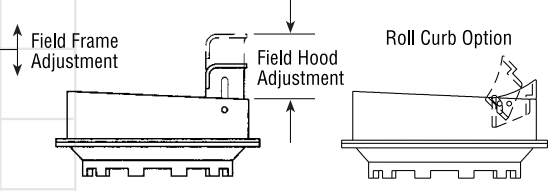
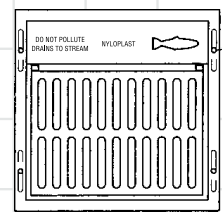



# Snout Structure

The Snout Structure is a Nyloplast catch basin with a plastic composite hood device attached to the inside wall of the catch basin structure designed to cover the outlet pipe in such a manner to prevent the exit of floating debris and oil.

## How the Snout Structure Works:

- Contaminated storm water is captured in the Nyloplast catch basin structure.
- Majority of floatable trash and debris, and some free oils and grease, separate from water and float to top.
- Portion of the suspended solids settle to the bottom.
- Cleaner water from beneath surface flows through outlet pipe.

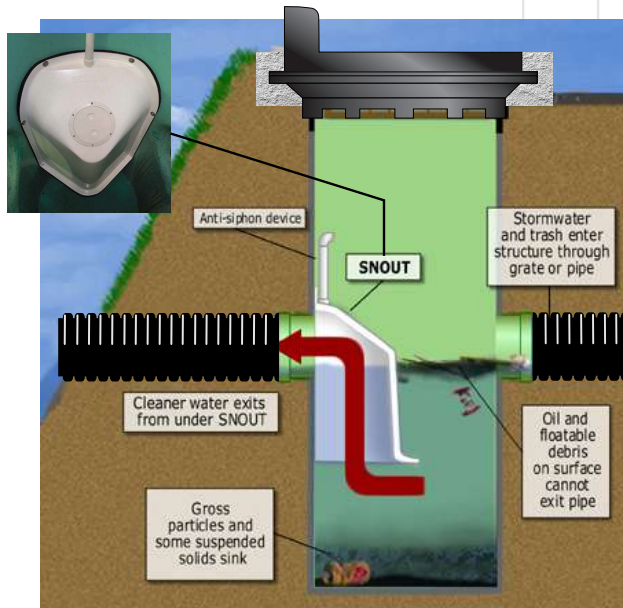

## Snout Structure Benefits:

- Effective low cost simple solution for storm water treatment.
- Captures up to 95% of floatables, while providing significant capture of free oils and suspended solids.
- Easy to clean.
- Very low head loss.
- Highly corrosion resistant for long service life.
- Prevents siphoning of trapped contaminants.
- Converts existing structures into oil and debris trap.

# Weir Structure

## How the Weir Structure Works:

- Storm water flows into the Nyloplast catch basin structure.
- The water flow is diverted to a desired outlet from the catch basin, typically to a water quality device, in order to effectively capture pollutants during the "first flush" of a storm event.
- The Weir Structure may also serve to restrict or regulate the flow of water exiting the drainage system. The restriction is determined by height of the weir and/or the size of the orifice hole in the weir plate.

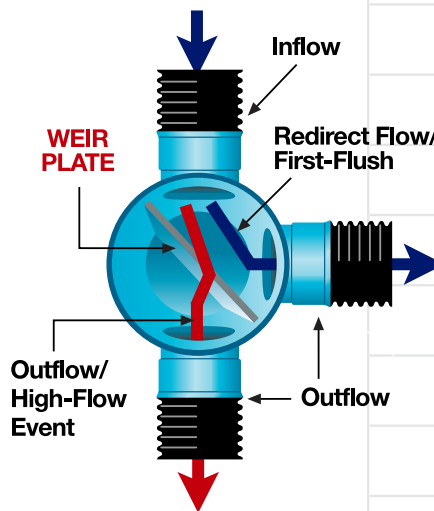

## Weir Structure Benefits:

- Simple and effective method to direct the inlet flow into a storm water management system or water quality device.
- Simple and effective method to regulate outlet flow from a storm water management system.
- Enhances ability of a water quality device to capture pollutants from storm event.
- Allows for flexibility to re-direct water flow during a high-flow event.
- Proven technology used for many years in the irrigation market.
- Nyloplast can customize Weir Structures (at the direction of the design engineer) to provide a variety of weir functions for site-specific needs, including "key way slot" and "v-notch" weir designs, and high flow or low flow orifice hole designs to further regulate the flow of storm water.





# Storm-PURE™ Filtration System

The Nyloplast Storm-PURE™ System with MYCELX™ technology stands alone in its ability to remove suspended solids, hydrocarbons and other pollutants from storm water runoff!

- Low cost BMP solution for hydrocarbon and debris removal
- Superior flow and bypass design ensures capture and eliminates back-up
- Quick and easy installation and maintenance requirements
- 99% hydrocarbon removal efficiency under test conditions
- Lloyds Register third party certified testing procedure and removal rates

## Storm PURE FILTRATION SYSTEM

Filter By: **MYCELX**

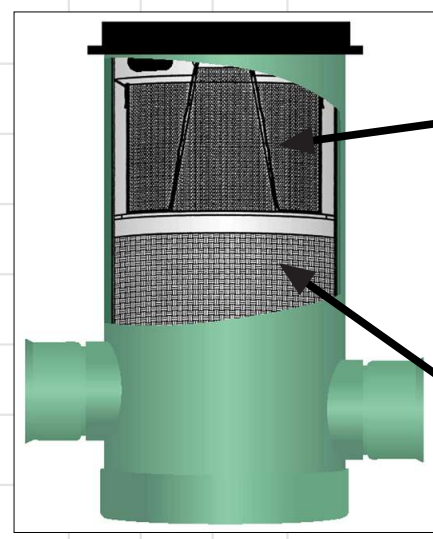

- Sediment/debris catch basket
- Geotextile filter bag (primary filter)
- Storm-PURE body



- MYCELX filter

### Pollutant Removal Performance

Analyzed Components	Unit	Reporting Limit	Influent	Effluent	Removal
Total Suspended Solids (TSS)	mg/L	5	36	11	69.44%
Total Petroleum Hydrocarbons (TPH)	mg/L	5	96.9	BRL	99.90%
*Chemical Oxygen Demand (COD)	mg/L	10	156	BRL	94.23%
*Nitrogen	mg/L	0.2	1.49	BRL	99.33%
*Total Phosphorus	mg/L	0.25	19.7	12.8	35.03%
*Iron	ug/L	100	1490	362	75.70%
*Copper	ug/L	5	86.2	11.5	86.66%
*Lead	ug/L	1	1110	106	90.45%
*Zinc	ug/L	10	6060	286	95.28%

\*Removal related to the components bonding with hydrocarbon molecules. BRL - Below Reporting Limit

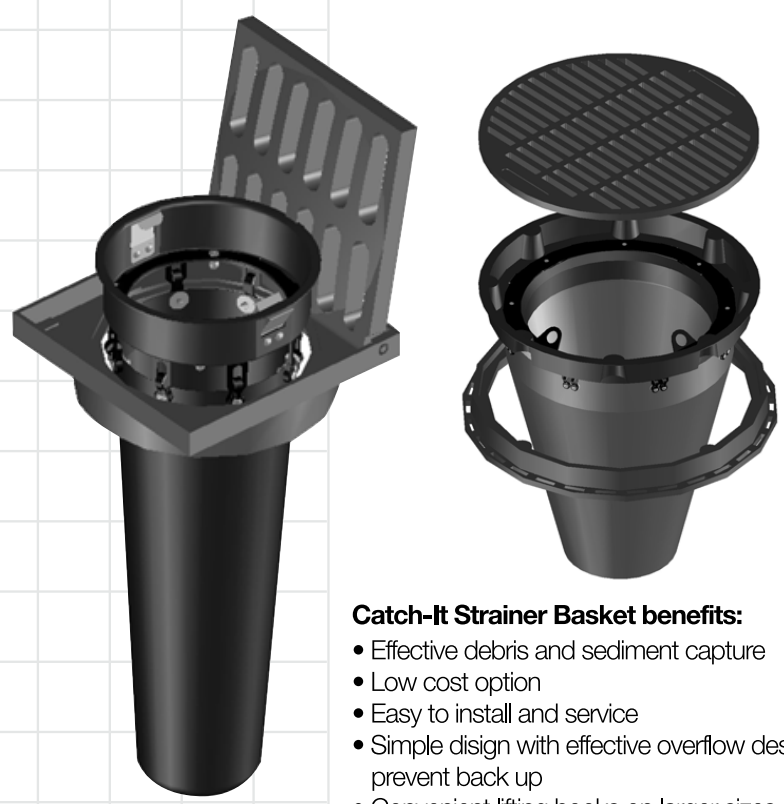

### Catch-It Strainer Basket benefits:

- Effective debris and sediment capture
- Low cost option
- Easy to install and service
- Simple design with effective overflow design to prevent back up
- Convenient lifting hooks on larger sizes
- BMP Solution

## "Catch-It" Strainer Basket

The Nyloplast "Catch-It" is a removable catch basin insert fitted with a heavy duty geosynthetic fabric basket. It is designed to fill the needs of both construction and post construction applications. The short version is ideal for Inline Drains and other drainage structures with availability in 12", 15", 18", 24", & 30". The long version fits inside the 12", 15", 18", 24", & 30" Drain Basins, Curb Inlet Structures and Road & Highway Structures.



# Add-a-Branch

Now you can quickly and easily add a new inlet/outlet to a Nyloplast Drain Basin, Curb Inlet Structure or Road and Highway Structure on site with only a drill and a jig saw. Or, if the location of the inlet/outlet is undetermined, you can order your Nyloplast structure without outlets and use an Add-a-Branch in the field.



# ADD-a-BRANCH™

Now, adding a stub to a Nyloplast Structure in the field is simple.



## The Patented Add-a-Branch Innovation

Includes Ring, Template and Bell Spigot Adapter

Part#/Prefix	Product Description	Minimum Structure Size
6004AG_	4" Add-a-Branch Field Installation Kit	8"
6006AG_	6" Add-a-Branch Field Installation Kit	10"
6008AG_	8" Add-a-Branch Field Installation Kit	12"
6010AG_	10" Add-a-Branch Field Installation Kit	15"
6012AG_	12" Add-a-Branch Field Installation Kit	18"
6015AG_	15" Add-a-Branch Field Installation Kit	24"
6004AG_30	4" Add-a-Branch Field Installation Kit Adapting to 30" Structure	30"
6006AG_30	6" Add-a-Branch Field Installation Kit Adapting to 30" Structure	30"
6008AG_30	8" Add-a-Branch Field Installation Kit Adapting to 30" Structure	30"
6010AG_30	10" Add-a-Branch Field Installation Kit Adapting to 30" Structure	30"
6012AG_30	12" Add-a-Branch Field Installation Kit Adapting to 30" Structure	30"
6015AG_30	15" Add-a-Branch Field Installation Kit Adapting to 30" Structure	30"
6018AG_30	18" Add-a-Branch Field Installation Kit Adapting to 30" Structure	30"

# PVC Structures Made To Your Specifications



The Preferred Solution for Storm Drainage Applications.

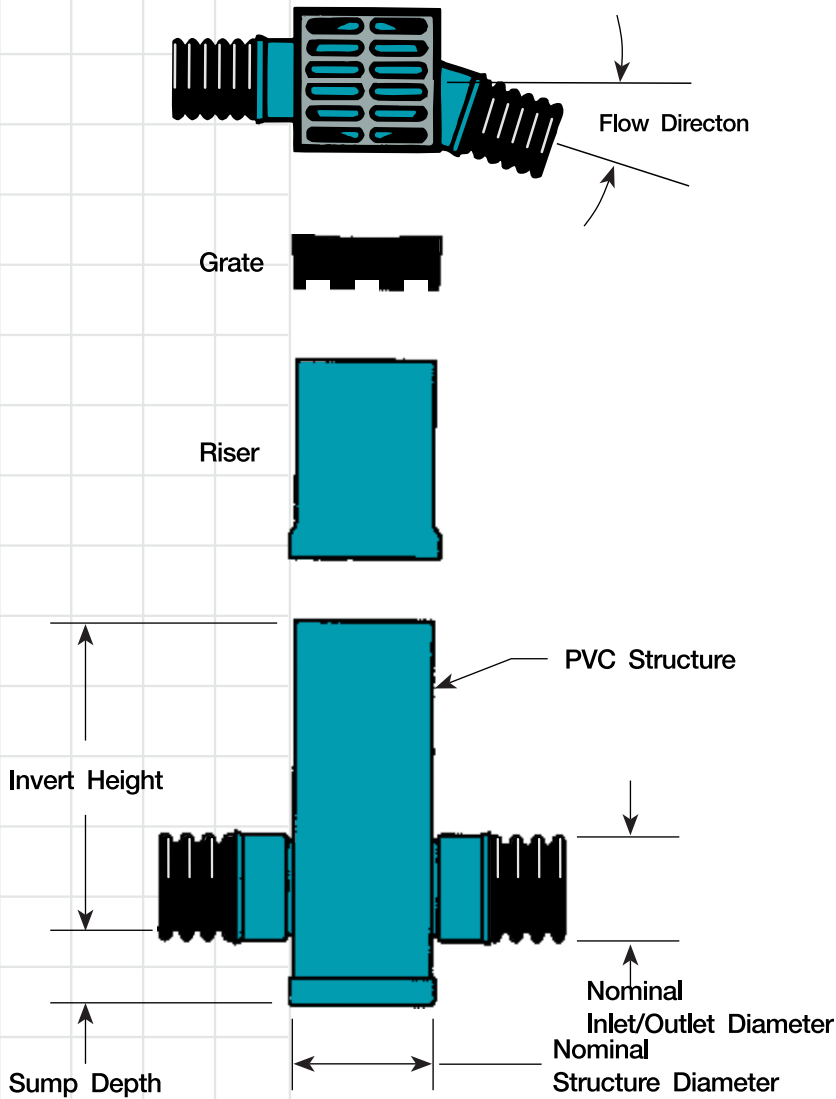

## All Nyloplast drainage structures are made to your specifications, which include:

- Nominal diameter of drain basin structure
- Nominal diameter of each inlet and outlet as well as the pipe design
- Invert height
- Flow direction of each inlet and outlet
- Sump depth  
(Specify only if different from standard. Standard being 6" on all basins except 30". On a 30" basin, the sump is 8" to 10").
- Grate options

## Field Adjustments

Since it is very common for the actual elevation of the job site to deviate from the plans used to make a drainage take-off, Nyloplast drainage structures are designed for easy adjustment in the field. In the event the elevation is less than expected, the drainage structures can be cut to size. If the elevation is greater than anticipated, riser sections are offered up to 6' in 1' increments, which can be used to extend a drainage structure.





# Strategic Location

## STRATEGIC SHIPPING LOCATIONS

The strategic location of our manufacturing facilities in Georgia, California and Ohio make for fast arrival just about anywhere in North America. In fact, once you've worked with our products and experienced our service, we're confident you'll be impressed.

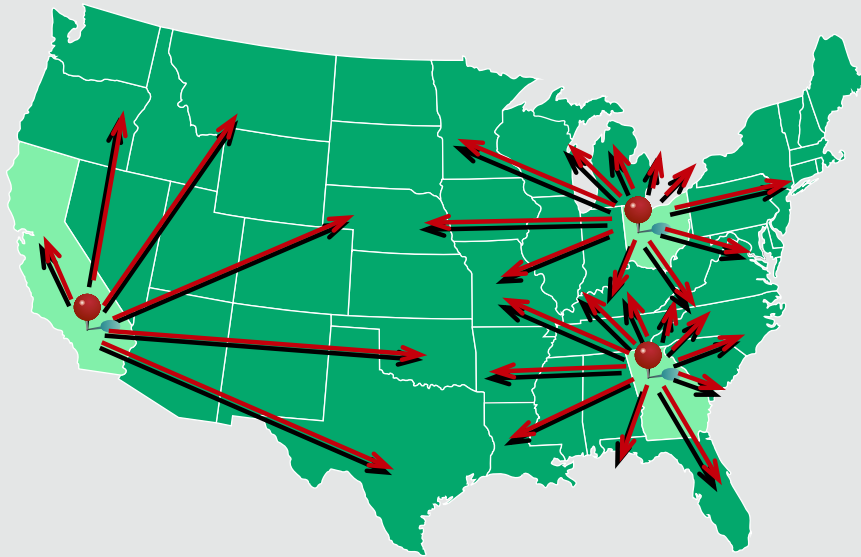

  
**Nyloplast**<sup>®</sup> Tomorrow's  
Storm Drainage  
Structures Today.



<http://www.ads-pipe.com>

3130 Verona Avenue • Buford, Georgia 30518 • (866) 888-8479 / (770) 932-2443 - Fax: (770) 932-2490



Nyloplast<sup>®</sup>, Add-a-Branch<sup>™</sup> and StormPURE<sup>™</sup> Systems are registered trademarks of Nyloplast.  
ADS<sup>®</sup> is a registered trademark of Advanced Drainage Systems, Inc. Mycelx<sup>®</sup> is a registered trademark of Mycelx Inc.  
Snout<sup>®</sup> is a registered trademark of BMP, Inc. and is protected by US Patent #6126817. ©2007 Nyloplast